

# PRORIL

## HANDY & RESIDUE PUMPS



50 Hz





# HANDY & RESIDUE PUMPS

Simple Structure, Real Quality

Designed for light weight, excellent performance, low energy consumption, and easy maintenance, PRORIL's submersible handy and residue pumps serve a wide range of pumping applications on utility, construction, industrial, and municipal job sites.







# SMART SERIES

## HANDY & RESIDUE PUMPS

Compact, lightweight and easy to use, the SMART series pumps deliver high performance for their size. These small but effective dewatering pumps are easily maintained and perfect for a variety of applications, such as small construction sites, rental industries, and municipal jobs.

### FEATURES

#### 1 Watertight Cable Entry

The cable entry employs an anti-wicking block where each conductor is stripped and encapsulated in epoxy. This feature effectively prevents water from penetrating the motor chamber when the cable end is submerged or the cable sheath is damaged.

#### 2 Top Discharge and Double Housing Design

Designed to construct a water jacket that provides maximum motor cooling effect for continuous operation at low water level, this feature forms the cylindrical and slim shape of the pump and enables the pump to be installed in confined spaces.

#### 3 Motor Protector

The motor incorporates a circle thermal protector which protects against overheating and dry-run.

#### 4 Submersible Motor

Air filled motor, housed in a watertight casing, conforms to Class F insulation.

#### Anti-wicking

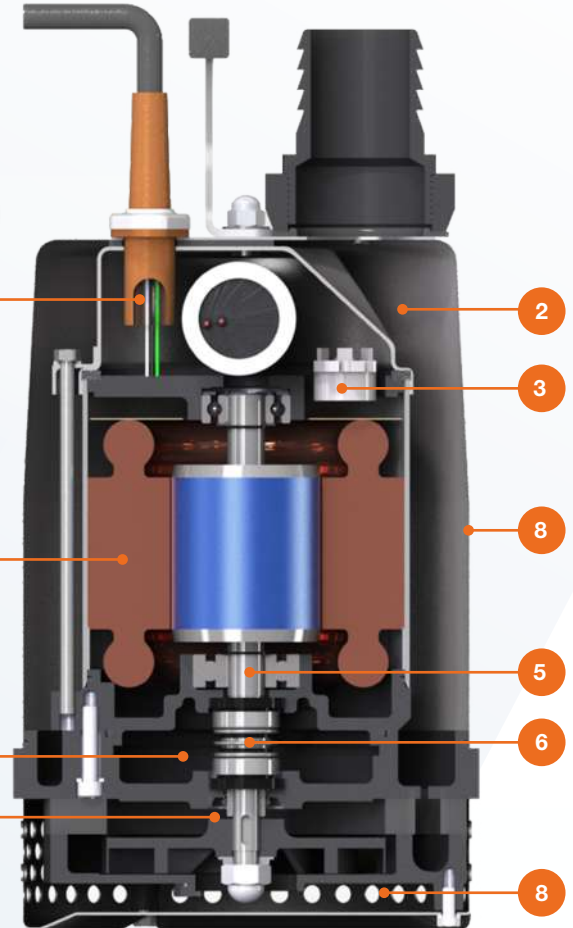

The above images are for illustration purposes only, please refer to datasheets for more details.

#### 5 C3 Ball Bearings and Hardened SS Shaft

High quality of C3 ball bearings and the well-balanced, hardened stainless steel shaft enhance stability during continuous pumping operations.

#### 6 Double Mechanical Seals

Located in the oil chamber, the device is made of quality materials with highly wear-resistant silicon carbide in lower side that provides extra protection against leakage and dry-run.

#### 7 Extra Protection for Mechanical Seals and Shaft

Lip seals and shaft sleeves are utilized for additional protection against wear.

#### 8 Durable Outer Jacket and Strainer

The outer housing and strainer made of 304 stainless steel provide impact resistant to harsh handling and conditions.

#### 9 Food Grade Lubricant

PRORIL adopts eco-friendly lubricant to minimize environmental impacts.



## SMART

## 400 750



SMART	400	750
Outlet	2" (50mm)	2" (50mm)
Rated Output	0.4kW	0.75kW
Shaft Speed	2850 rpm	2850 rpm
Solid Passage	5.5mm	7mm
Height	329mm	356mm
Diameter	Ø184mm	Ø184mm
Weight	13kg	14kg

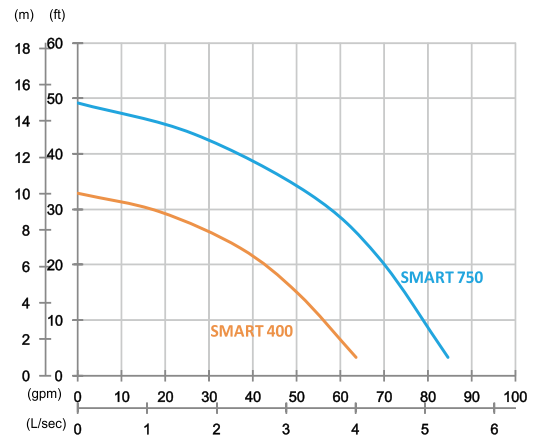

## SMART

## 1500



SMART	1500
Outlet	2" (50mm)
Rated Output	1.5kW
Shaft Speed	2850 rpm
Solid Passage	9mm
Height	433mm
Diameter	Ø225mm
Weight	24kg

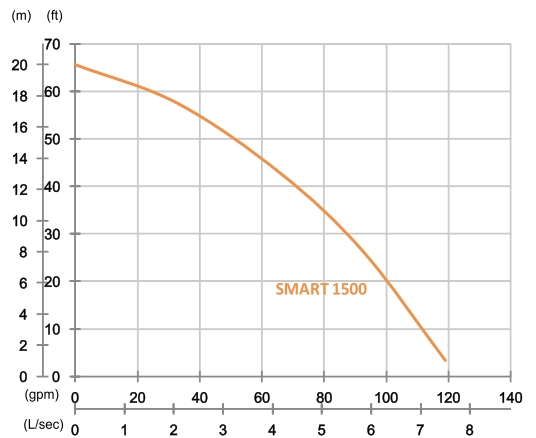

## SMART BASE

## 400



SMART BASE	400
Outlet	2" (50mm)
Rated Output	0.4kW
Shaft Speed	2850 rpm
Solid Passage	2mm
Height	336mm
Diameter	Ø206mm
Weight	14kg

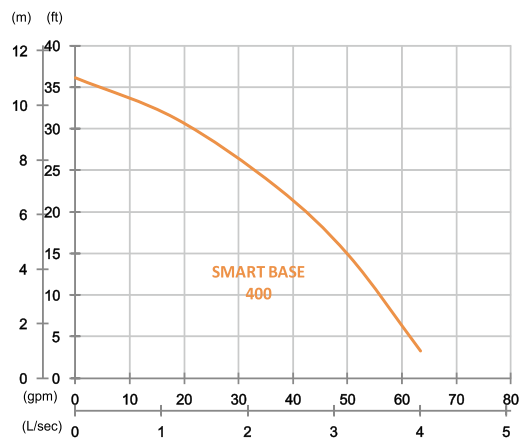

# SMART LITE

Small, lightweight and cost-effective, the SMART LITE pumps perform an excellent job for their size. These small but effective dewatering pumps are easily maintained and perfect for a variety of applications, such as small construction sites, rental industries, and municipal jobs.

## FEATURES

- **Watertight cable entry** prevents water incursion from the capillary wicking.
- **Multi-Direction Discharge** can be changed between vertical and horizontal ways.
- **Slim line design** allows access into limited space.
- **Double housing** forms a water jacket to greatly cool the motor.
- **A thermal protector** is used on the motor to protect against overheating and dry-run.
- **Air filled motor** housed in a watertight casing, conforms to Class F insulation.
- **C3 Ball Bearings and Hardened SS Shaft** enhance stability during operation.
- **Mechanical Sic Seal** in lower side provides extra protection against leakage and dry-run.
- **A Lip Seal** works as an extra protection for mechanical seal from wear.
- **PU Impeller** is adopted for easy maintenance.
- **Food Grade Lubricant** helps minimizing environmental impacts.

## SMART LITE

## 400 750



SMART LITE	400	750
Outlet	2" (50mm)	2" (50mm)
Rated Output	0.4kW	0.75kW
Shaft Speed	2850 rpm	2850 rpm
Solid Passage	7mm	7mm
Height	303mm	343mm
Diameter	Ø205mm	Ø205mm
Weight	11kg	13kg

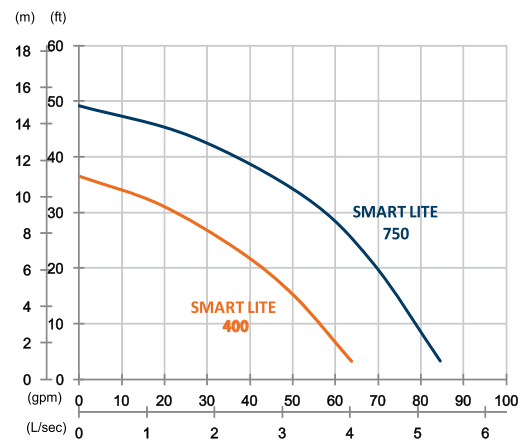

## SMART LITE BASE

## 400



SMART LITE BASE	400
Outlet	2" (50mm)
Rated Output	0.4kW
Shaft Speed	2850 rpm
Solid Passage	2mm
Height	304mm
Diameter	Ø215mm
Weight	11kg

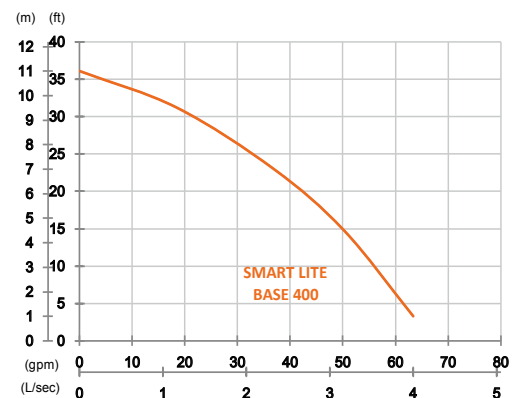

# SMART VOX

Equipped with an agitator, SMART VOX pumps are light-weight and cost-effective sludge pumps. These portable and effective sludge pumps are easily maintained and perfect for a variety of applications, such as small construction sites, rental industries, and municipal jobs.

## FEATURES

- **Watertight cable entry** prevents water incursion from the capillary wicking.
- **A thermal protector** is used on the motor to protect against overheating and dry-run.
- **Air filled motor** housed in a watertight casing, conforms to Class F insulation.
- **C3 Ball Bearings and Hardened SS Shaft** enhance stability during operation.
- **Mechanical Sic Seal** in lower side provides extra protection against leakage and dry-run.
- **A Lip Seal** works as an extra protection for mechanical seal from wear.
- **Shaft-mounted Agitator** functioning with side discharge and a semi-vortex PU impeller forms a large channel in the spiral casing and allows sand and slit-laden water to pass through efficiently.
- **Impact-Resistant Suction Stand** is made for easy cleaning and maintenance.
- **Food Grade Lubricant** helps minimizing environmental impacts.

## SMART VOX

## 400



SMART VOX	400
Outlet	2" (50mm)
Rated Output	0.4kW
Shaft Speed	2850 rpm
Solid Passage	7mm
Height	350mm
Diameter	Ø253mm
Weight	12kg

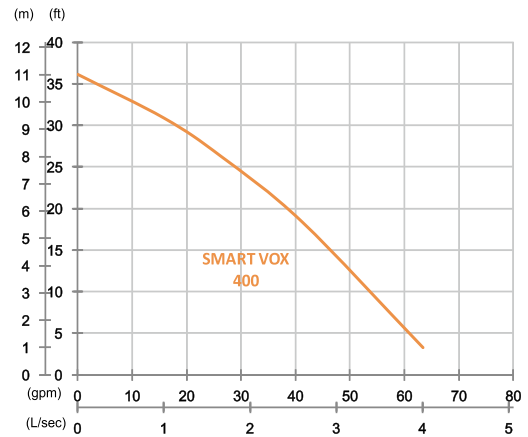

## SMART VOX

## 750



SMART VOX	750
Outlet	2" (50mm)
Rated Output	0.75kW
Shaft Speed	2850 rpm
Solid Passage	7mm
Height	377mm
Diameter	Ø253mm
Weight	13kg

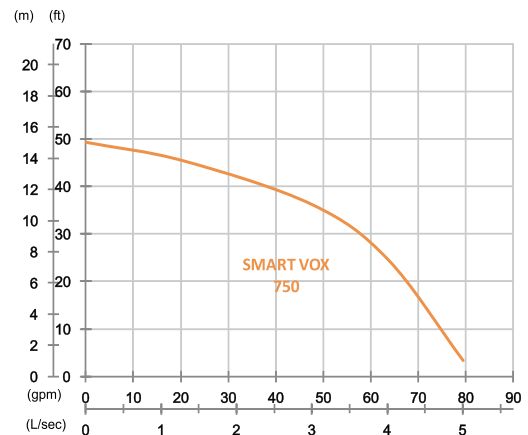



# SAVVY SERIES

## HANDY & RESIDUE PUMPS

The SAVVY series pumps are suitable for a variety of domestic applications, including draining basements and garages, emptying swimming pool and fountains, gardening, and hobby applications in general.

### FEATURES

#### 1 Watertight Cable Entry

Watertight cable entry prevents water incursion from the capillary wicking.

#### 2 Durable Outer Housing

The outer housing made of 304 stainless steel provides impact resistant to harsh handling and conditions.

#### 3 Motor Protector

The motor incorporates a miniature thermal protector which protects against overheating and dry-run.

#### 4 Submersible Motor

Air filled motor, housed in a watertight casing, conforms to Class F insulation.

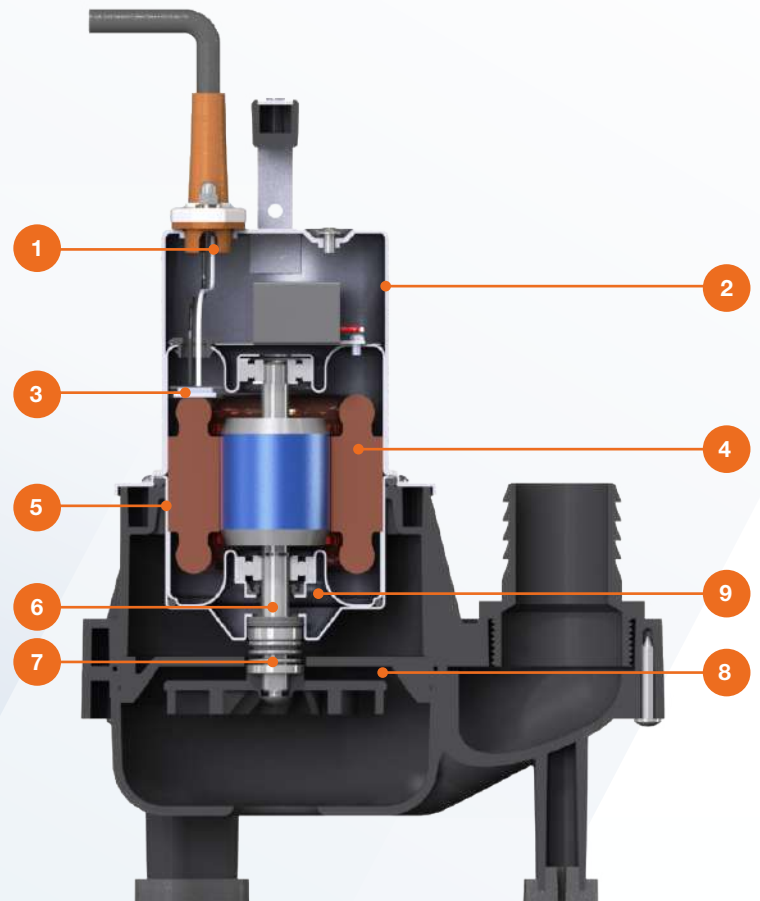

The above images are for illustration purposes only, please refer to datasheets for more details.

#### 5 Stainless Steel 304 Motor Housing

The material provides superior corrosion resistance.

#### 6 C3 Ball Bearings and Hardened SS Shaft

High quality of C3 ball bearings and the well-balanced, hardened stainless steel shaft enhance stability during continuous pumping operations.

#### 7 Mechanical Seal

The premium mechanical seal provides extra protection against leakage and longer life span.

#### 8 Impact-resistant Nylon pump casing and suction grid

Lightweight design and corrosion-resistance.

#### 9 Food Grade Lubricant

PRORIL adopts eco-friendly lubricant to minimize environmental impacts.





## SAVVY

### 300 600



SAVVY	300	600
Outlet	2" (50mm)	2" (50mm)
Rated Output	0.25kW	0.55kW
Shaft Speed	2850 rpm	2850 rpm
Solid Passage	6mm	6mm
Height	306mm	341mm
Diameter	Ø244mm	Ø244mm
Weight	4kg	6kg

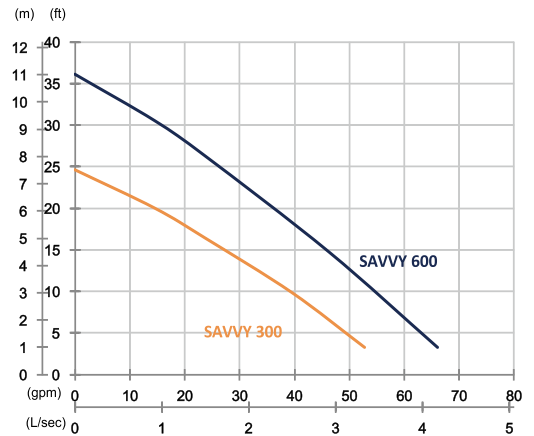

## SAVVY JUMBO

### 300 600



SAVVY JUMBO	300	600
Outlet	2" (50mm)	2" (50mm)
Rated Output	0.25kW	0.55kW
Shaft Speed	2850 rpm	2850 rpm
Solid Passage	35mm	35mm
Height	337mm	372mm
Diameter	Ø245mm	Ø245mm
Weight	5kg	6kg

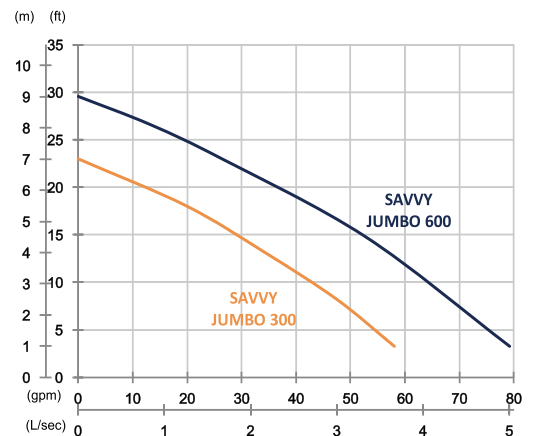

## SAVVY BASE

### 300 600



SAVVY BASE	300	600
Outlet	1" (25mm)	2" (50mm)
Rated Output	0.25kW	0.55kW
Shaft Speed	2850 rpm	2850 rpm
Solid Passage	2mm	2mm
Height	304mm	357mm
Diameter	Ø244mm	Ø244mm
Weight	4kg	6kg

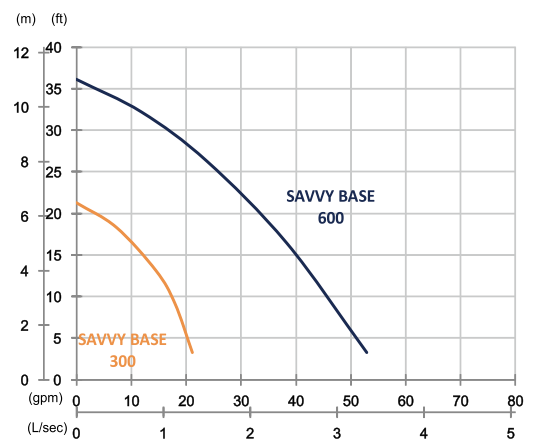

# SAVVY 100 / 150 / 200

## FEATURES

- Compact, lightweight, and easy-to-use design
- SAVVY 100 /150 : Aluminum alloy outer case with lightweight top cover, impeller, and suction grids.
- SAVVY 200 : Stainless Steel 304 motor housing with lightweight top cover, pump casing, impeller, and suction grids.
- Air filled motor with Class F insulation.
- Thermal protection on motor.
- Built-in high torque capacitor.
- Triple seals design.
- Removable filter screen for easy maintenance.

### SAVVY

### 100 150



SAVVY	100	150
Outlet	0.75" (20mm)	0.75" (20mm)
Rated Output	0.1kW	0.15kW
Shaft Speed	2850 rpm	2850 rpm
Solid Passage	6mm	6mm
Height	273mm	273mm
Diameter	Ø158mm	Ø158mm
Weight	3kg	3.2kg

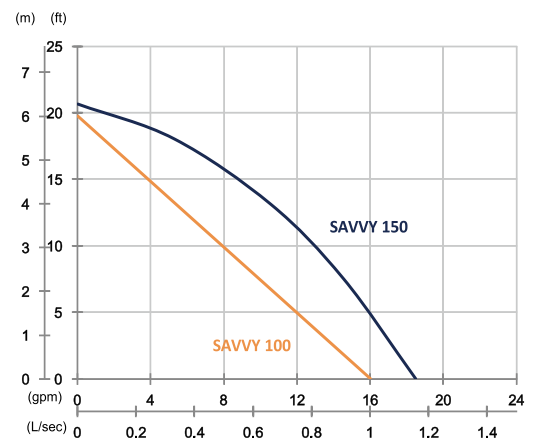

### SAVVY

### 200



SAVVY	200
Outlet	0.75" (20mm)
Rated Output	0.25kW
Shaft Speed	2850 rpm
Solid Passage	6mm
Height	275mm
Diameter	Ø204mm
Weight	4kg

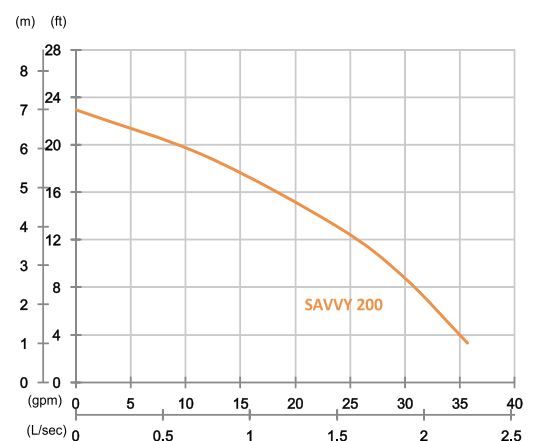



---

## PRORIL

---

PRORIL was established in 1979, starting from a small motor factory where it has transformed itself into a global size submersible pump manufacturer. Its perseverance and dedication of making high quality products and maintaining a strong working etiquette are mere images of the founder's belief and philosophy that contribute to the success of PRORIL.

With decades of experiences, PRORIL specializes in submersible pump manufacturing service, and continues investing in the fluid dynamics design, motor efficiency enhancement, and R&D of various metal alloys. The integration of upstream and downstream suppliers has completed the manufacturing chain that PRORIL proudly offers to its customers. PRORIL goes through stringent quality procedures where its quality management system conforms to the global standards.

Up to now, PRORIL had recognized by various international awards by the persistence of product quality and continuous improvement according to market demand. Through the recognition of the awards, PRORIL is more determined to provide better services and products to customers.

Today, PRORIL has developed a complete product line that covers dewatering pumps, sewage pumps, slurry pumps, and others. They are applicable in general drainage, construction, industrial sites, wastewater treatment, sludge removal, and so on. Furthermore, PRORIL's professional R&D team continuously improves the product performance to meet various needs in tough dewatering applications.

The success of PRORIL has been based on unyielding commitment and attitude to technical excellence and unparalleled dedication to customer service. Honesty and integrity have further contributed to a worldwide collaboration and connection to a long-term sustainable relationship with all our customers. In future, PRORIL will continue to excel and serve every PRORIL's customer with our professionalism, enthusiasm, and trust.



---

## MORE PRODUCTS

---



**DEWATERING PUMPS**



**SLURRY & SAND PUMPS**



**SEWAGE PUMPS**



**STAINLESS STEEL PUMPS**



[WWW.PRORIL.COM](http://WWW.PRORIL.COM)

---

**PRORIL PUMPS CORPORATION**

HD-50-109001